

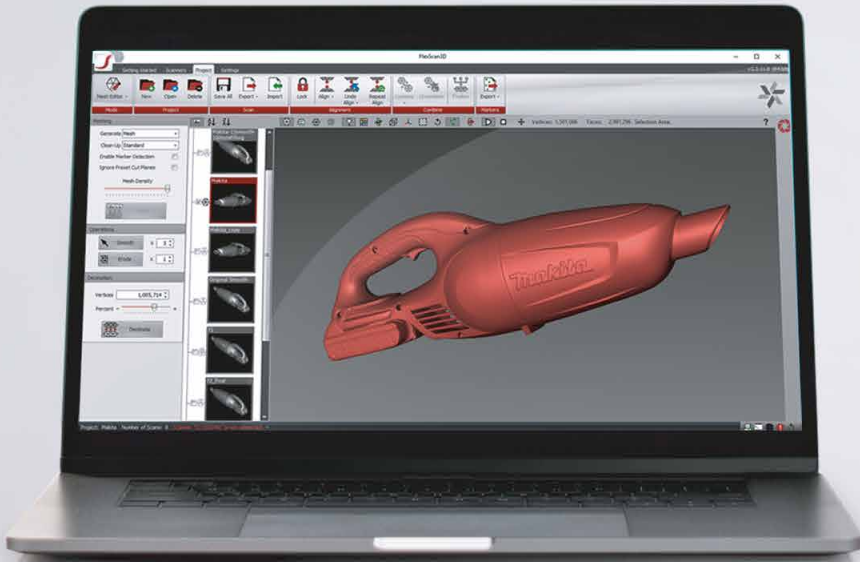

# Plug and Play 3D Scanner

Get Industrial Quality Results, Every Time.



The HDI Compact professional 3D scanners are factory calibrated for repeatable measurement accuracy you can trust. Start 3D scanning in no time.



PLUG IN THE SYSTEM



INSTALL THE SOFTWARE



READY FOR SCANNING

HDI Compact 3D scanners are ready to capture 3D scans with millions of surface measurement points accurately only minutes after setup. They take digital 3D scans from real-world objects with the click of a button, [saving you time and improving on productivity.](#)



✉ [contact@polyga.com](mailto:contact@polyga.com)

🌐 [www.polyga.com](http://www.polyga.com)

Tom O'Mahoney is a researcher at Anglia Ruskin University. He uses the HDI Compact 3D scanner for cultural heritage, physical anthropology, and palaeontology.

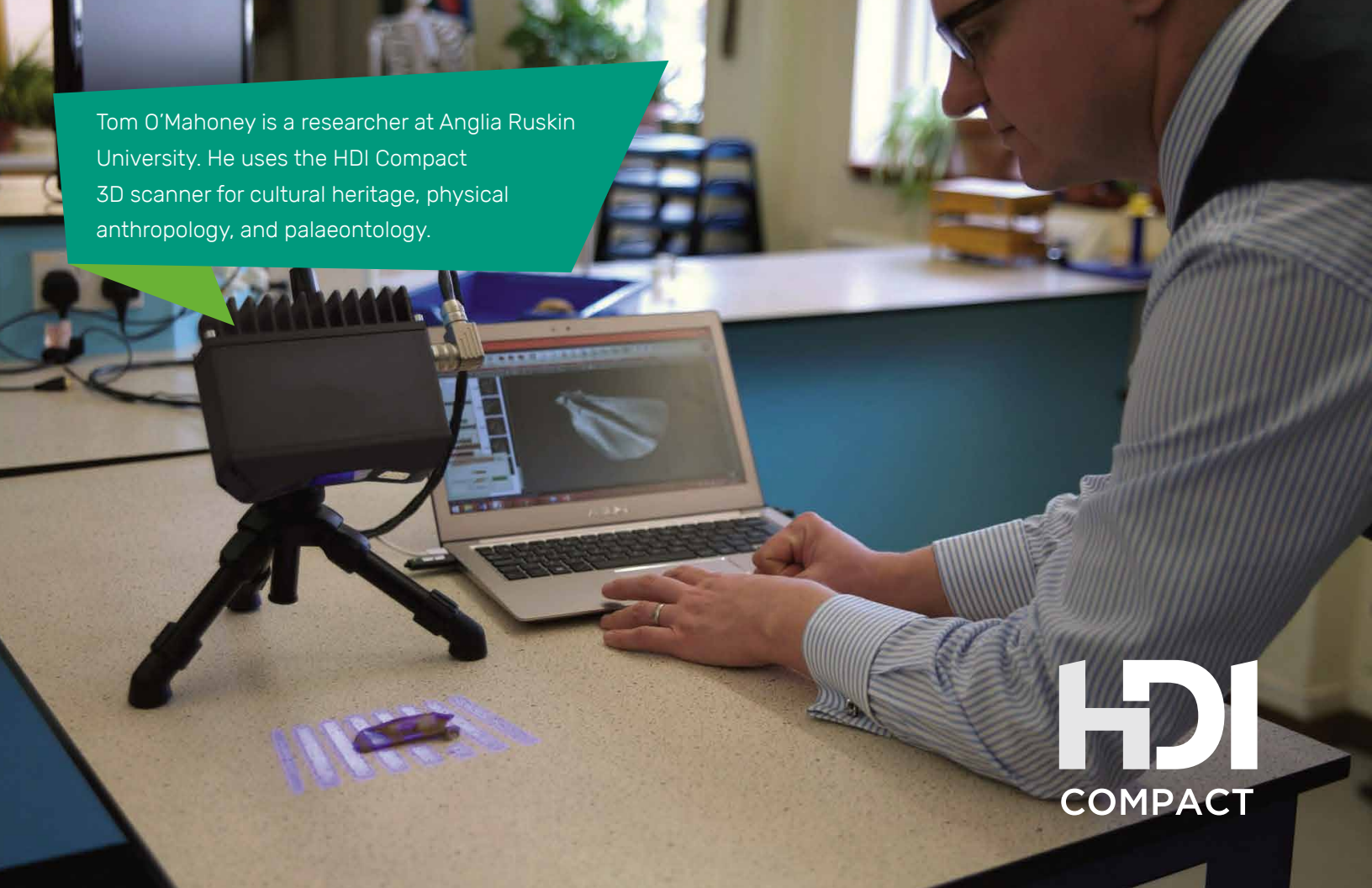

# HDI COMPACT

## FULL FIELD SCANNING

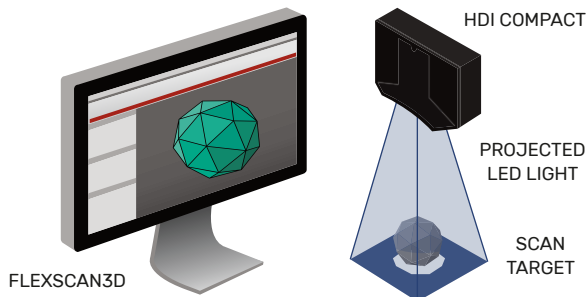

The HDI Compact is a non-contact measurement solution using LED structured-light technology. The system provides full-field scanning at an ultrafast scan speed of a fraction of a second.

## IMPRESSIVE SCAN QUALITY

With the click of a button, the HDI Compact captures industrial quality 3D scans containing 1 to 5 million 3D data points from real-world objects (*depending on 3D scanner model*). Designed for demanding industry applications, you can depend on the HDI Compact for accurate and repeatable scanning results.

## VERSATILE AND READY TO GO



HDI Compact is slim and portable

The 3D scanner works great as a standalone desktop 3D scanner, integrating into systems, or embedding into devices. It's easy to take along for travelling. Put it in your suitcase or travel case and you're ready to go.

## BUILT IN POST-PROCESSING CAPABILITIES

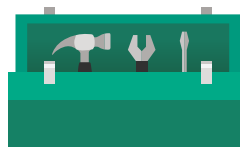

Process scan data at the capturing stage with FlexScan3D. The 3D scanning software has aligning, merging, and hole filling capabilities to transform 3D scans into a complete digital 3D model. Export

the output for use in downstream applications including 3D visualization, reverse engineering, and quality inspection.

# HDI Compact

## Professional 3D Scanner Models

### MODEL L

Large Field of View



Field of View (mm):  
265 x 225 – 375 x 345

### MODEL C

Industrial



IP67 Rated Housing  
Dust proof and water resistant



Durable Exterior  
Solid aluminum body

Scan Small Objects



C210

Field of View (mm):  
98 x 71 – 154 x 100



C506

Field of View (mm):  
45 x 27 – 45 x 30



C504

Field of View (mm):  
13.2 x 12.1 – 15.0 x 13.0

Entry-Level

### MODEL S

## HDI COMPACT S1

### Affordable 3D Scanner

Delivering high-quality results rarely seen  
in an entry-level professional system



Field of View (mm):  
65 x 58 – 90 x 80

# Powerful 3D Scanning Systems

## AUTOMATING THE 3D SCANNING PROCESS

Eliminate the tedious process of manually scanning an object. Use a rotary turntable to revolve the scan target in 360 degrees. The HDI Compact 3D scanners capture the scans in minutes and merge them together to create a full digital 3D model.

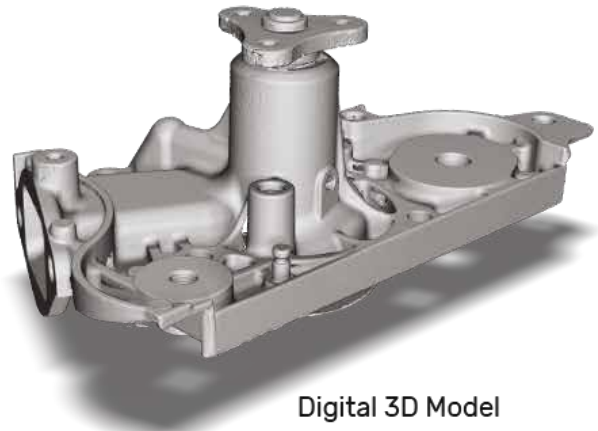

Digital 3D Model

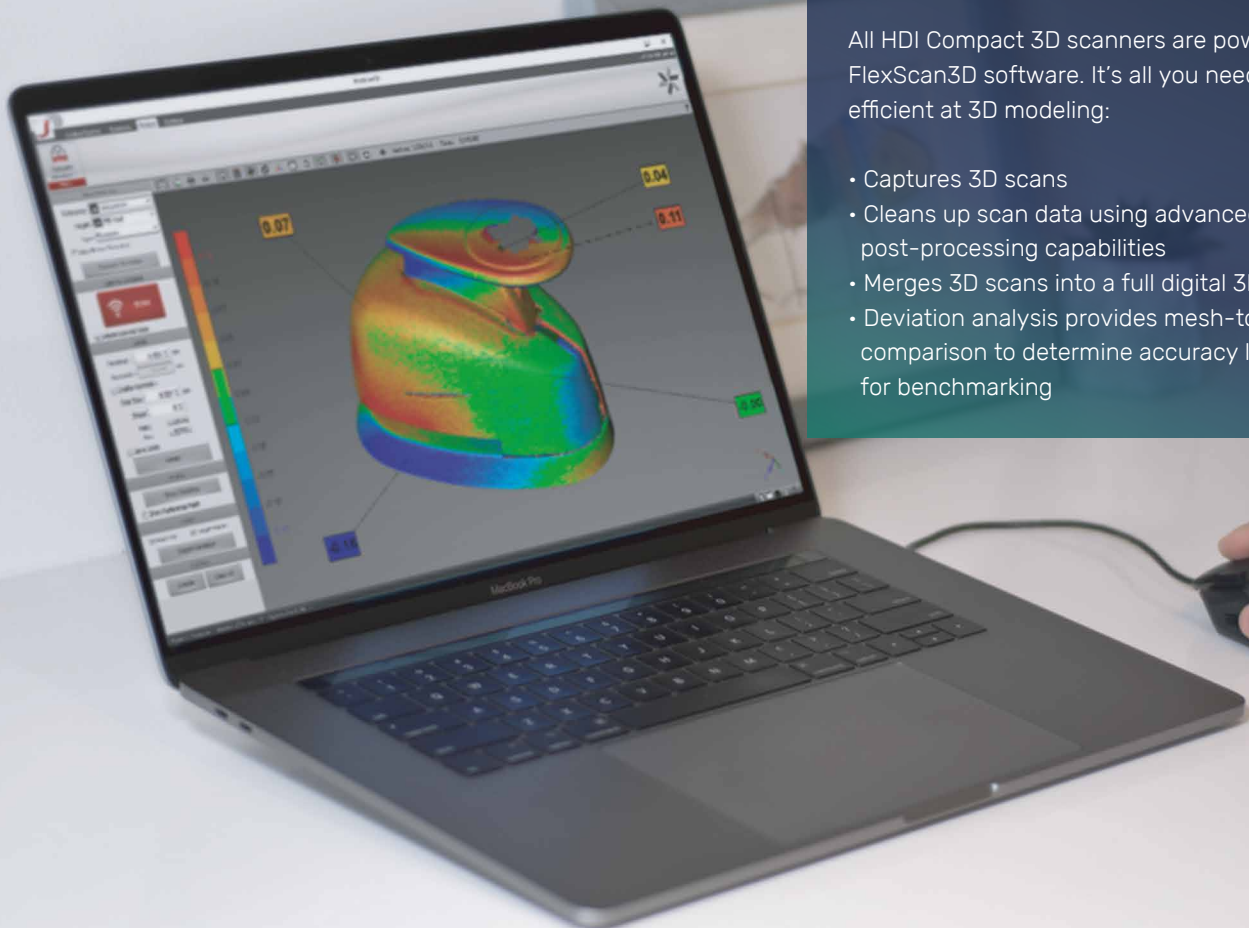

## DO IT ALL IN FLEXSCAN3D

All HDI Compact 3D scanners are powered by FlexScan3D software. It's all you need to be efficient at 3D modeling:

- Captures 3D scans
- Cleans up scan data using advanced post-processing capabilities
- Merges 3D scans into a full digital 3D model
- Deviation analysis provides mesh-to-mesh comparison to determine accuracy level and for benchmarking



Handheld Vacuum Cleaner  
(HDI Compact L6)

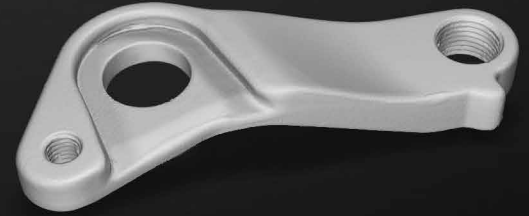

Bicycle Derailleur  
(HDI Compact S1)

### HDI COMPACT L6

### HDI COMPACT S1 **NEW**

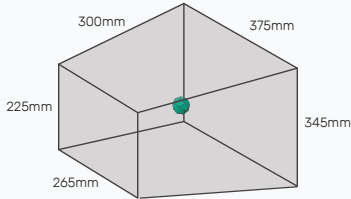
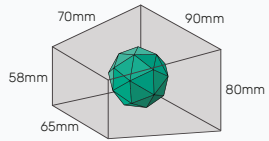
<b>Cameras</b>	2 x 3 monochrome megapixel cameras	2 x 1.3 monochrome megapixel cameras
<b>Dimension (mm)</b>	55 x 129 x 400	58 x 270 x 158
<b>Weight (kg)</b>	2	2
<b>Scanning Software</b>	FlexScan3D	FlexScan3D
<b>Scan Speed (milliseconds)</b>	1200	500
<b>Depth of Field (mm)</b>	300	70
<b>Field of View (mm)</b>	265 x 225 - 375 x 345 	65 x 58 - 90 x 80 
<b>Resolution</b>		
Average Points	3 million per scan	1.2 million per scan
Average Polygons	6 million per scan	2.4 million per scan
Point to Point Distance (mm)	0.18	0.07
<b>Accuracy</b>	Up to 80 microns	Up to 40 microns
<b>Clearance Distance (mm)</b>	680	220
<b>Geometry Formats</b>	PLY, OBJ, STL, ASC, FBX, 3D3	

**Minimum Computer Requirements**

Windows 7 (64-bit) Operating System, Quad-core Intel 2 GHz CPU or better, 4 GB Memory or greater, 512 MB Video Card, Free disk space 250 GB Hard Drive or more

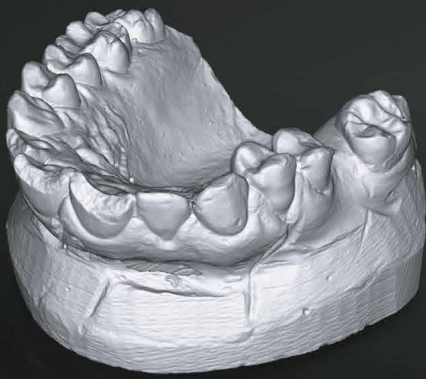

Dental Mold

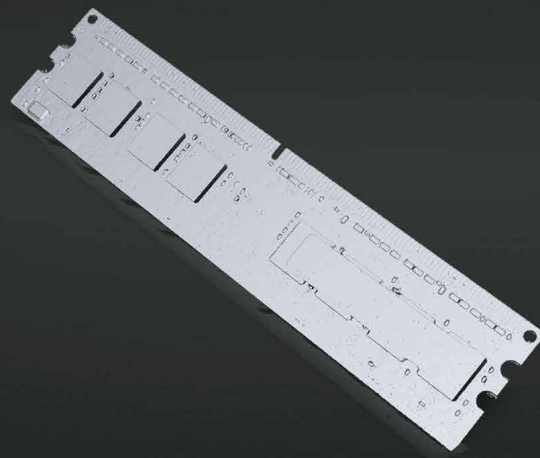

Computer Memory Card

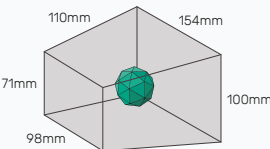
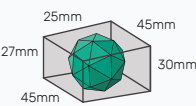
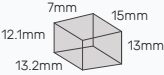

Metal Drill Bit Tip

	HDI COMPACT C210	HDI COMPACT C506	HDI COMPACT C504
<b>Cameras</b>	2 x 2 monochrome megapixel cameras	2 x 5 monochrome megapixel cameras	2 x 5 monochrome megapixel cameras
<b>Dimension (mm)</b>	49 x 146 x 190	49 x 136 x 170	49 x 152 x 178
<b>Weight (kg)</b>	1.7	1.52	1.77
<b>Scanning Software</b>	FlexScan3D	FlexScan3D	FlexScan3D
<b>Scan Speed (milliseconds)</b>	250	333	166
<b>Depth of Field (mm)</b>	110	25	7
<b>Field of View (mm)</b>	98 x 71 - 154 x 100 	45 x 27 - 45 x 30 	13.2 x 12.1 - 15.0 x 13.0 
<b>Resolution</b>			
Average Points	2 million per scan	5 million per scan	5 million per scan
Average Polygons	4 million per scan	10 million per scan	10 million per scan
Point to Point Distance (mm)	0.06 - 0.09	0.020 - 0.025	0.0067- 0.0071
<b>Accuracy</b>	Up to 35 microns	Up to 12 microns	Up to 6 microns
<b>Clearance Distance</b>	164	87	51.5
<b>Geometry Formats</b>	PLY, OBJ, STL, ASC, FBX, 3D3		

**Minimum**

**Computer Requirements**

Windows 7 (64-bit) Operating System, Quad-core Intel 2 GHz CPU or better, 4 GB Memory or greater, 512 MB Video Card, Free disk space 250 GB Hard Drive or more